

| REVISION | DESCRIPTION | CHECK | APP | DATE | REV. NOTICE. NO |
|----------|-------------|-------|-----|------|-----------------|
| 1 | | | | | |
| 2 | | | | | |
| 3 | | | | | |

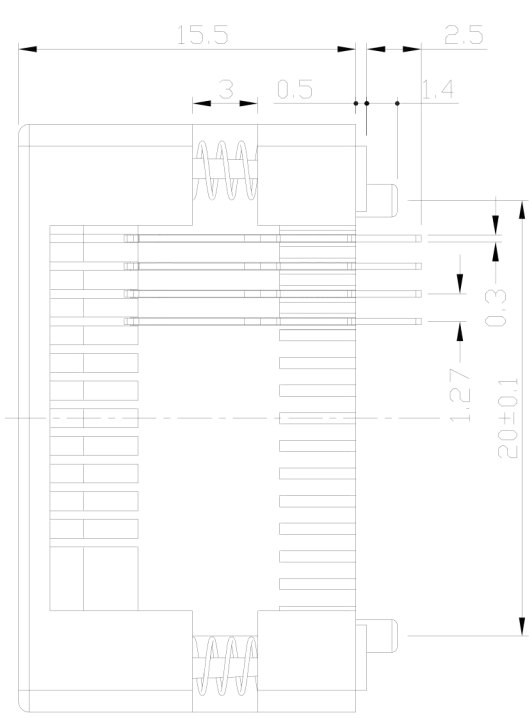

PCB PATTERN (TOP VIEW)

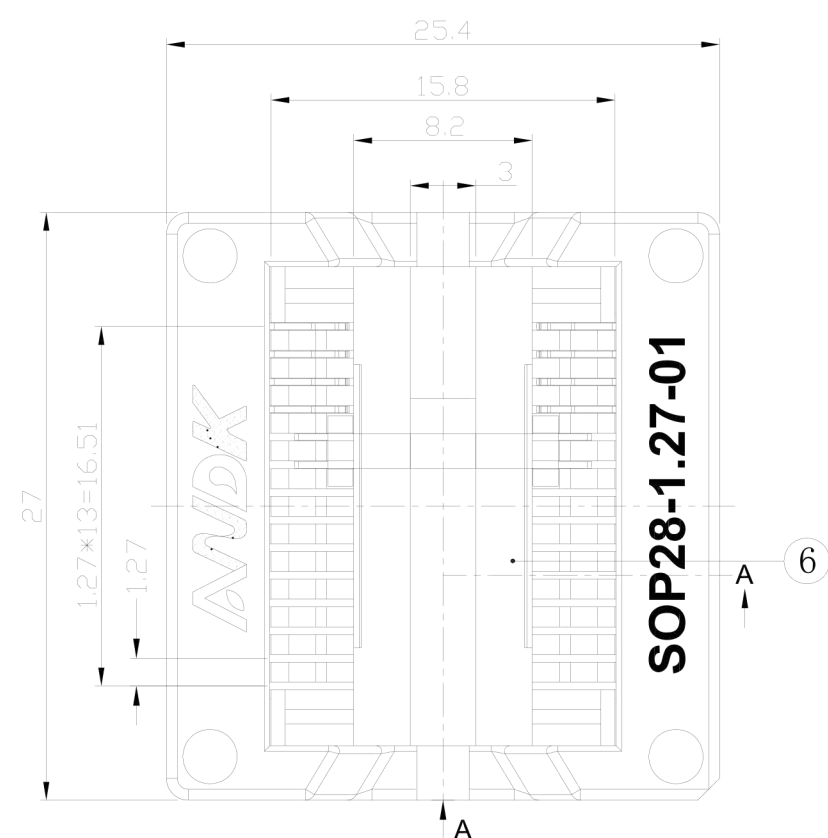
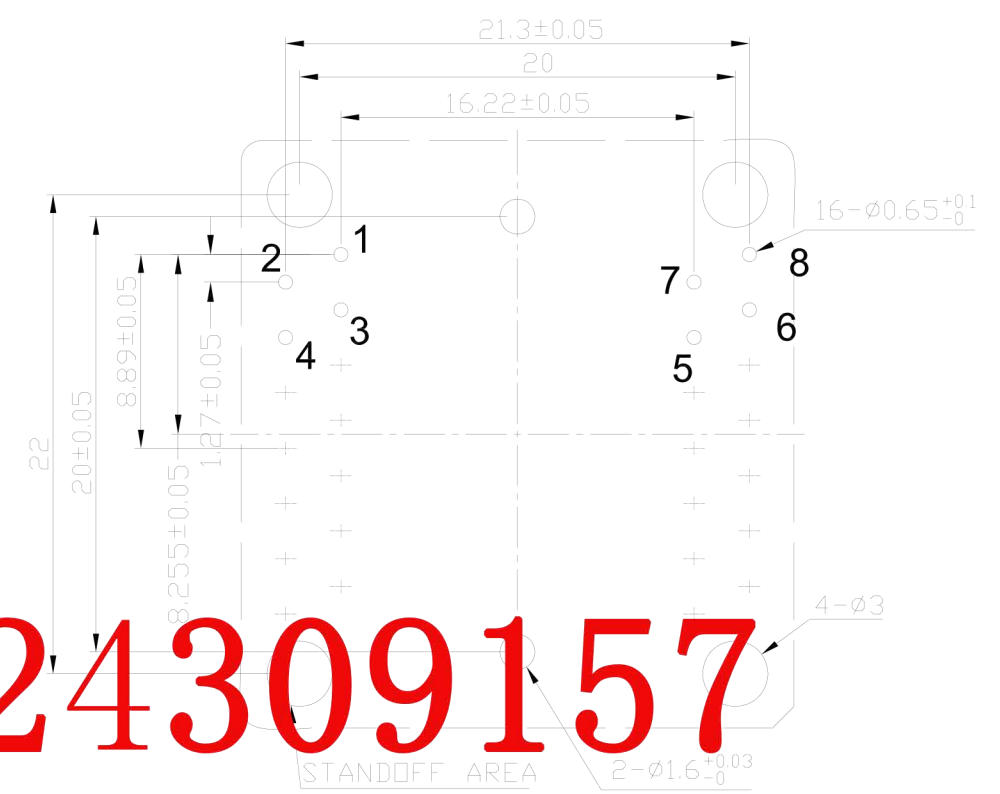

手机微信同号: 18824309157

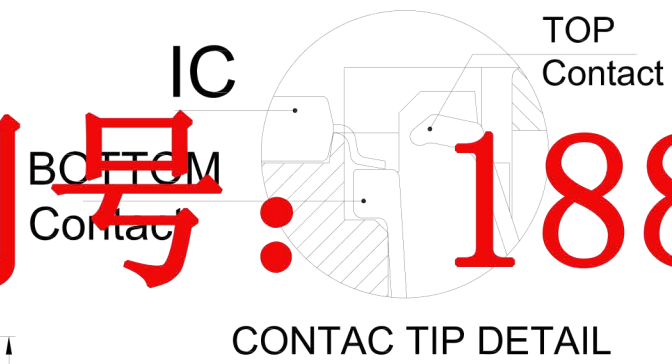

PERFORMANCE

1. Insulation Resistance: 1000mΩ Min.At DC 500V
2. Dielectric Withstanding Voltage For 1 Minute At AC 700V
3. Contact Resistance 30mΩ MAX. at 10mA and 20mV MAX.(Initial)
4. Current Rating: 1A max.
5. Operation Temperature -55°C ~+125°C
6. Life Span 15,000 Times (Mechanical)
7. Operation Force 1.0 Kg MAX

APPL ICABLE IC

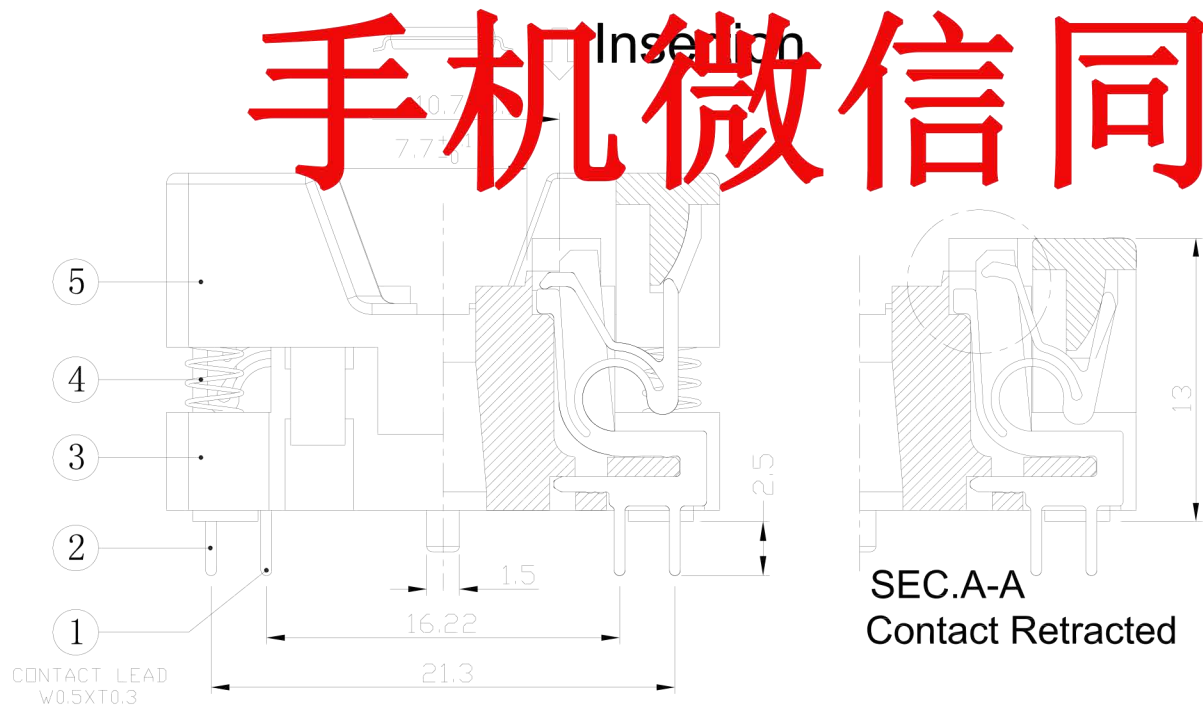
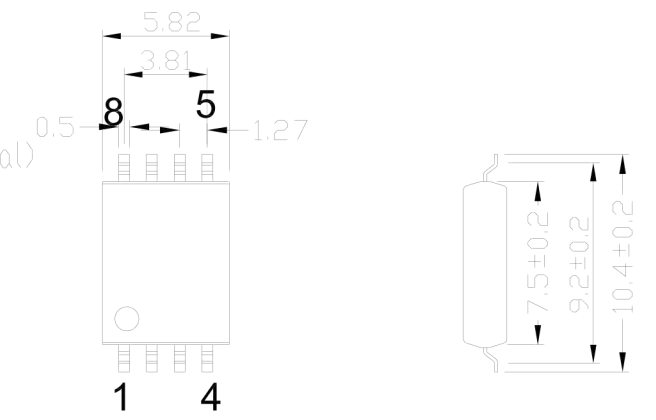

SEC.A-A

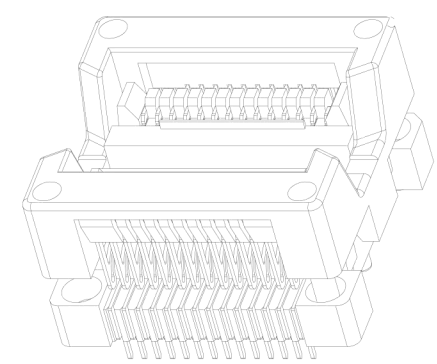

| No | Part Number | Name | Material | Q/ty | Note | TOLERANCE | PROJECTION | GENERAL TOLERANCES | REV | TITLE |
|----|----------------|---------|----------|------|------------|---------------|---------------|--------------------|-----|-----------------------|
| 6 | SOP-28-U01-003 | ADAPTER | PEI/PES | 1 | BLACK | | | ±0.10 | A | SOP28-1.27 SOCKET |
| 5 | SOP-28-U01-002 | COVER | PEI/PES | 1 | BLACK | | | | | SOP8 (28)-1.27-TP05NT |
| 4 | 30-B-4515X | SPRING | SUS | 4 | FDR COVER | X. ± 0.50 | DIMENSION: mm | SCALE: 1:1 | | OTS-8(28)-1.27-04 |
| 3 | SOP-28-U01-001 | BASE | PEI/PES | 1 | BLACK | X. X ± 0.25 | APP: | DATE: | | |
| 2 | SOP-28-MSBR-02 | CONTACT | BeCu | 4 | Au PLATING | X. XX ± 0.10 | CHECK: | DATE: | | |
| 1 | SOP-28-MSBR-01 | CONTACT | BeCu | 4 | Au PLATING | X. XXX ± 0.05 | DEGK: ENG02 | DATE: 20170318 | | |