

REVISION	DESCRIPTION	CHECK	APP	DATE	REV. NOTICE. NO
1					
2					
3					

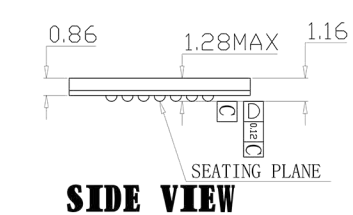
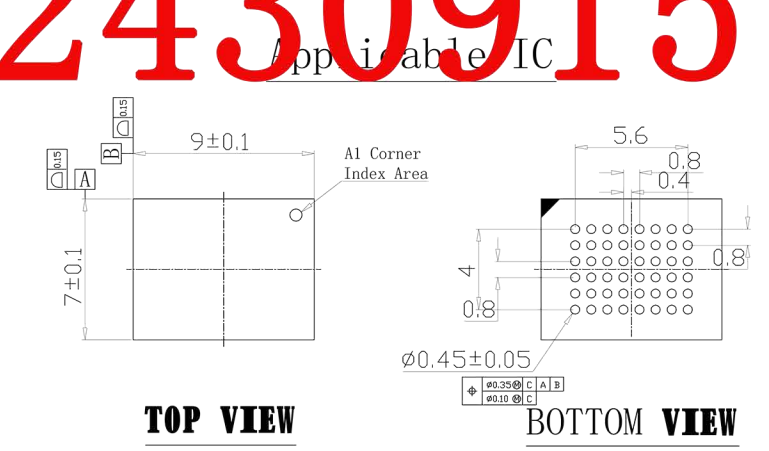
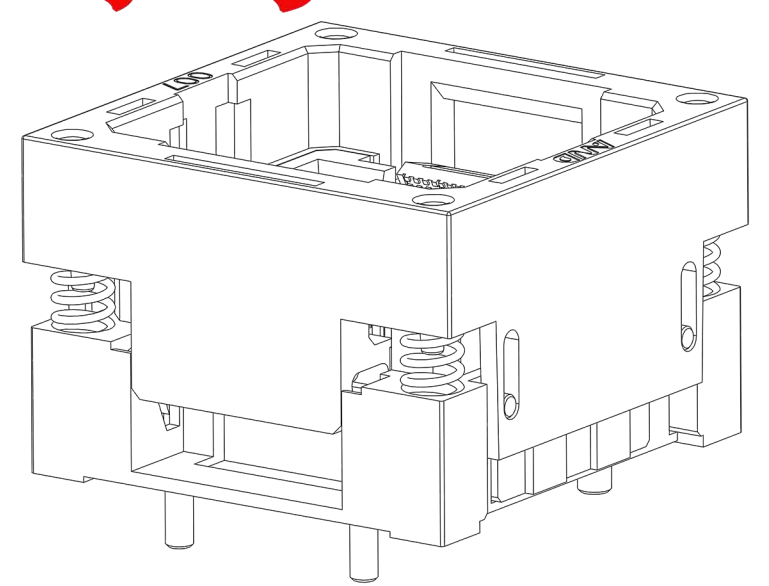
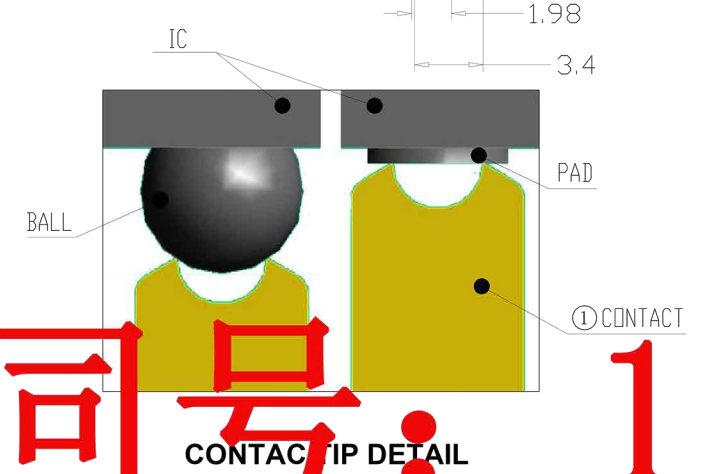
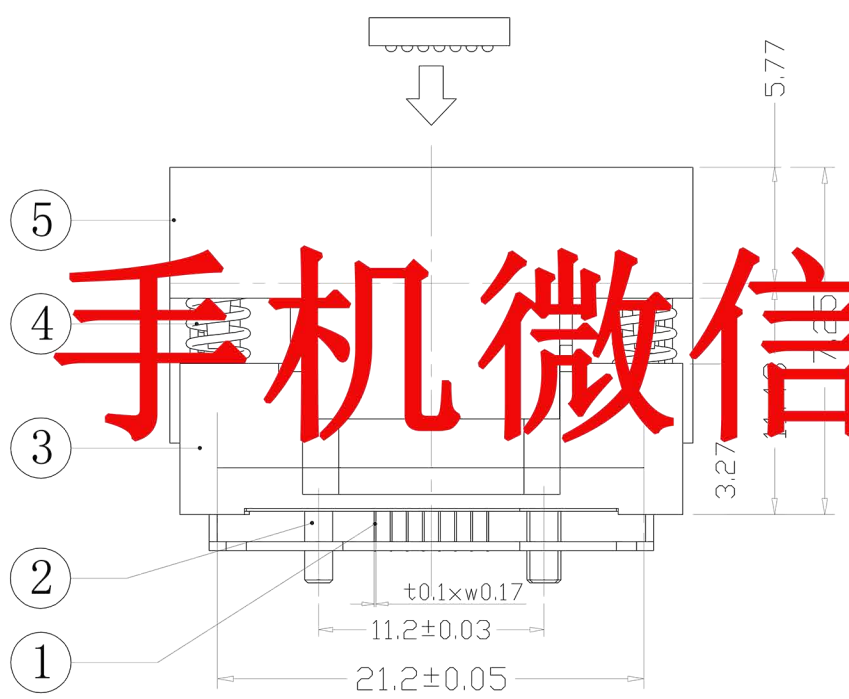
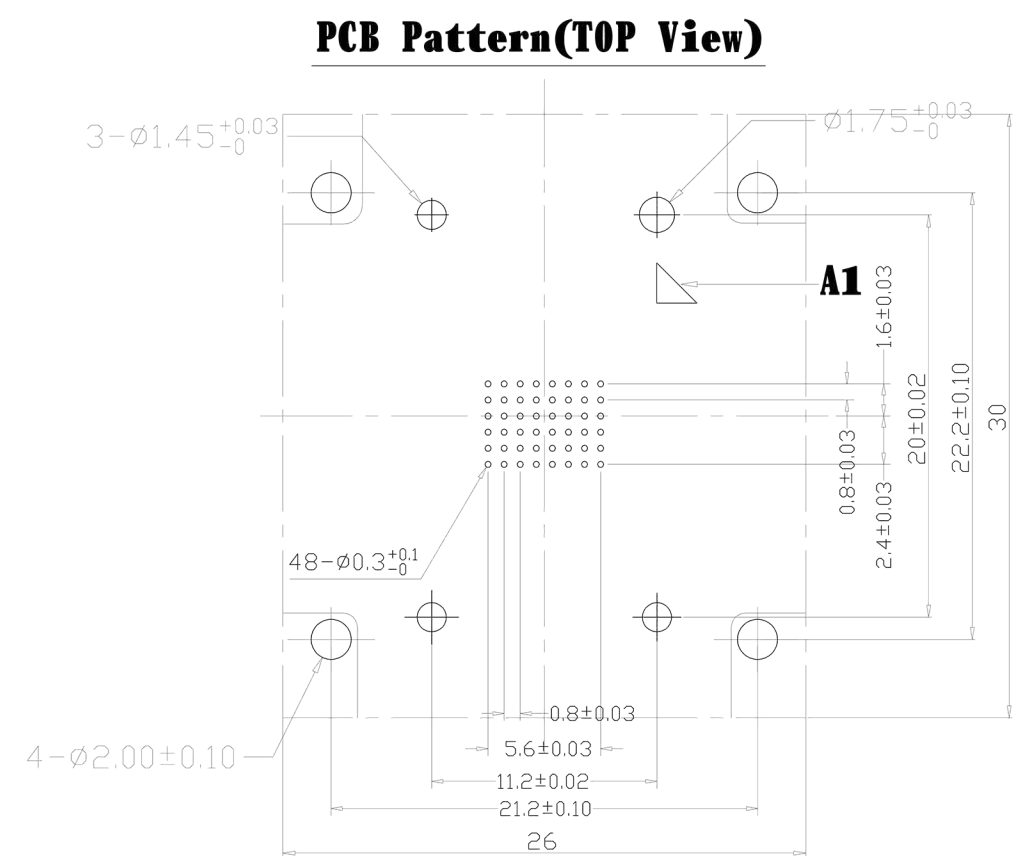
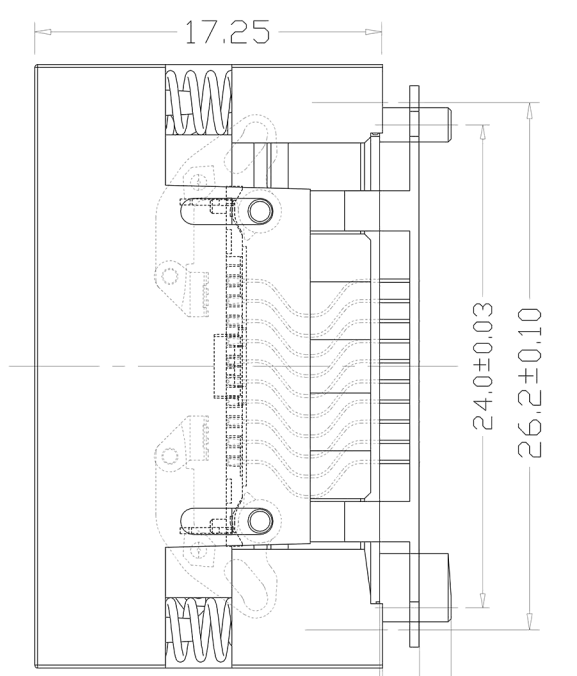
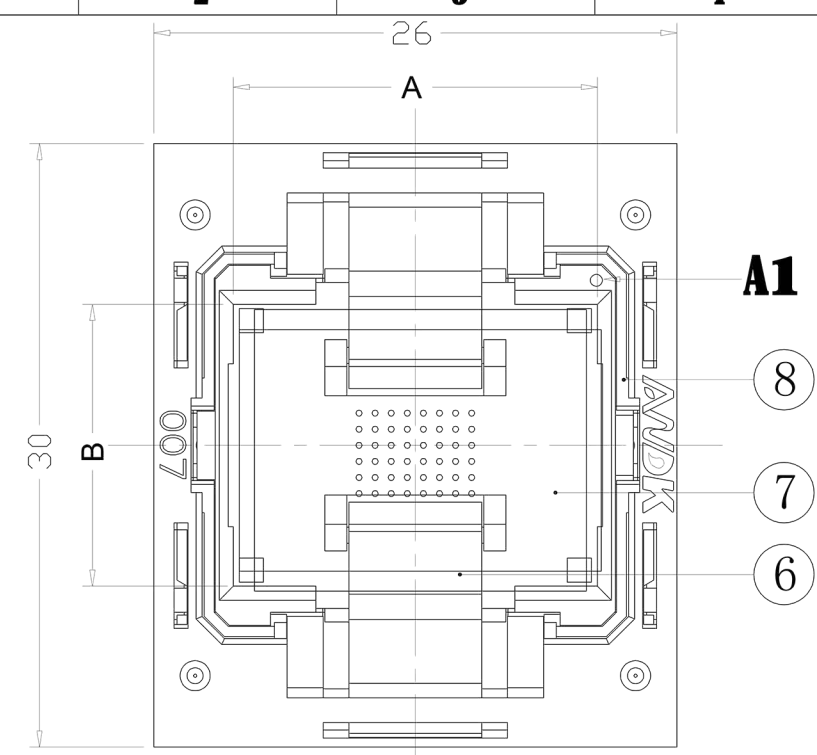

手机微信同号: 18824309157

PERFORMANCE

- 1、Insulation Resistance: 1000MΩ Min.At DC 500V
- 2、Dielectric Withstanding Voltage For 1 Minute At AC 700V
- 3、Contact Resistance 30mΩ MAX. at 10mA and 20mV MAX.(Initial)
- 4、Current Rating: 1A max.
- 5、Operation Temperature -65°C ~+175°C
- 6、Contact Force 3-5g Per Pin (Normal)
- 7、Testing chips with balls of different size or superficial oxidation,even if no ball

No	Part Number	Name	Material	Q/ty	Note
8	310-048-D105D	IC GUIDE	PEI/PES	2	BLACK
7	310-048-C105D	SLIDER	PEI/PES	1	BLACK
6	310-048-C105D	IC HOLDER	PEI/PES	2	BLACK
5	310-048-B105D	COVER	PEI/PES	1	BLACK
4	20-B-4505B	SPRING	SUS	4	FOR COVER
3	310-048-A105D	BASE	PEI/PES	1	BLACK
2	310-048-F105D	LOCATOR	PEI/PES	3	BLACK
1	04-A-1705	CONTACT	BeCu	48	Au PLATING

PROJECTION	GENERAL TOLERANCES	±0.10	TITLE	BGA4802 SOCKET
	REV	A	CLASS	007-22048D-2101
DIMENSION:	mm	SCALE:	1:1	DRW. NO
APP:		DATE:		
CHECK:		DATE:		
DEGK: ENG04		DATE: 20121227		