

REVISION	DESCRIPTION	CHECK	APP	DATE	REV. NOTICE. NO
1					
2					
3					

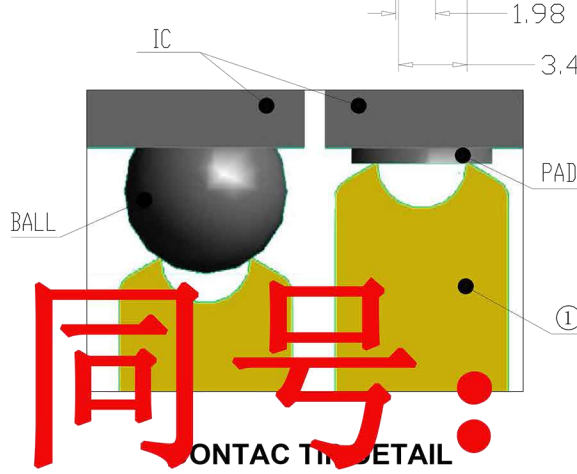

PCB Pattern(TOP View)

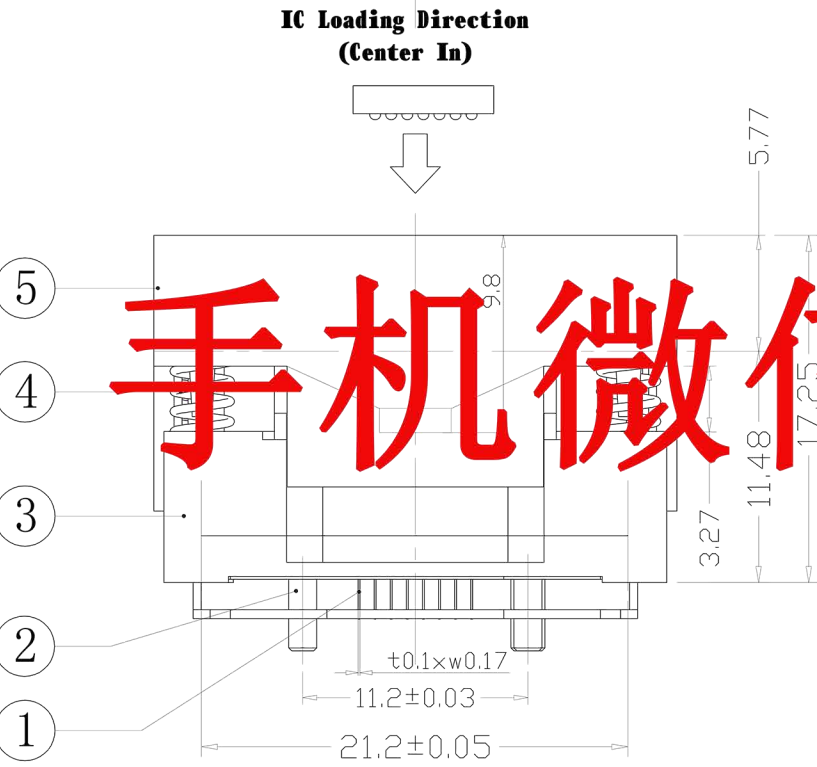
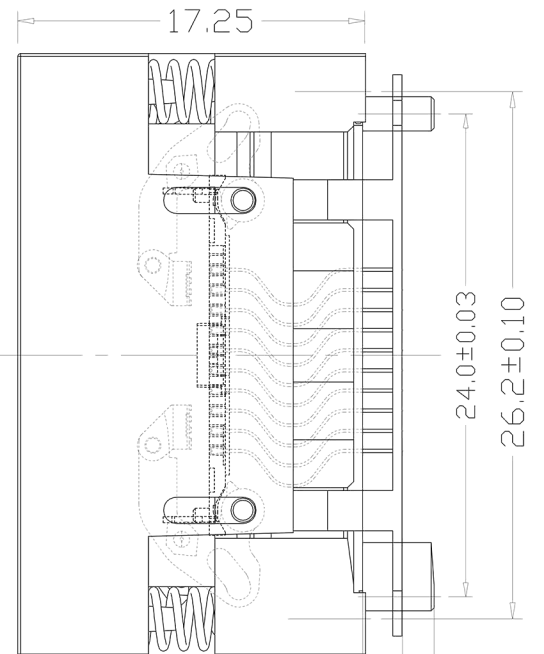
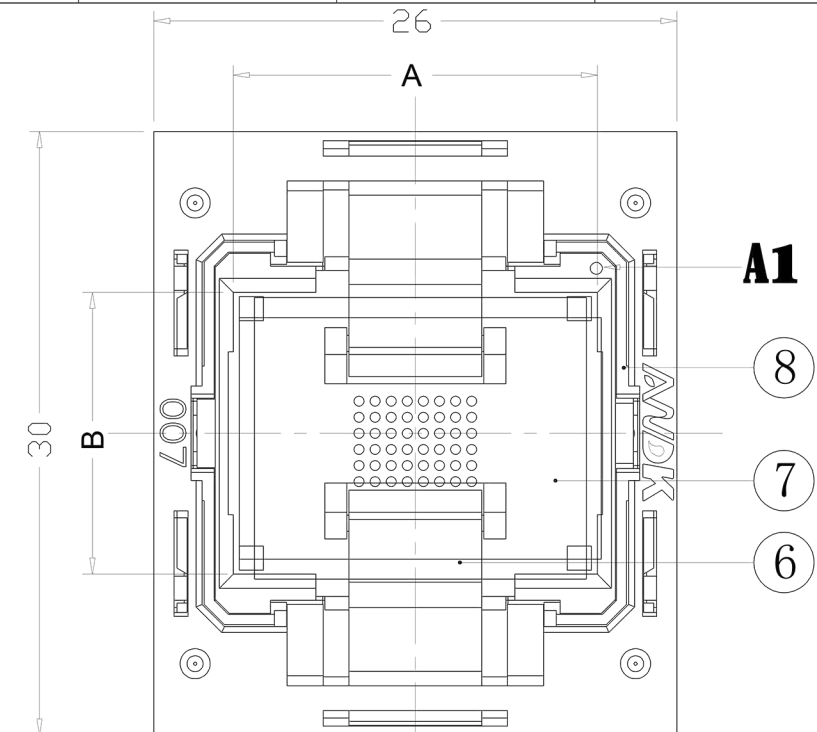
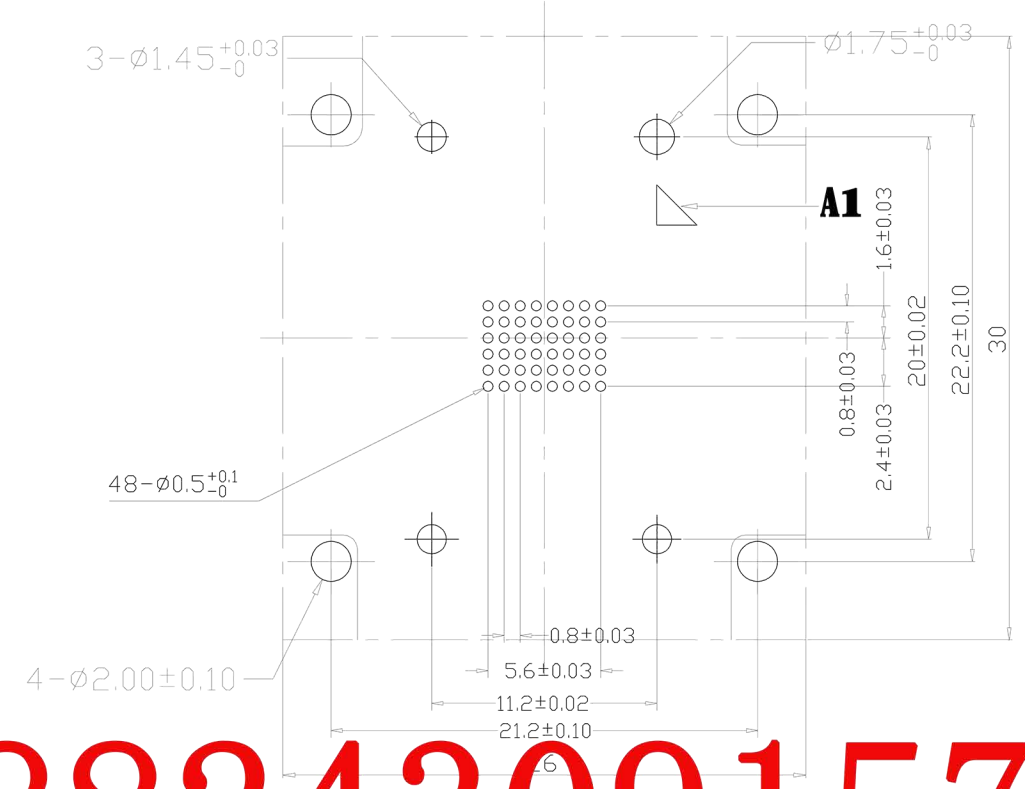

手机微信同号: 18824309157

Applicable IC

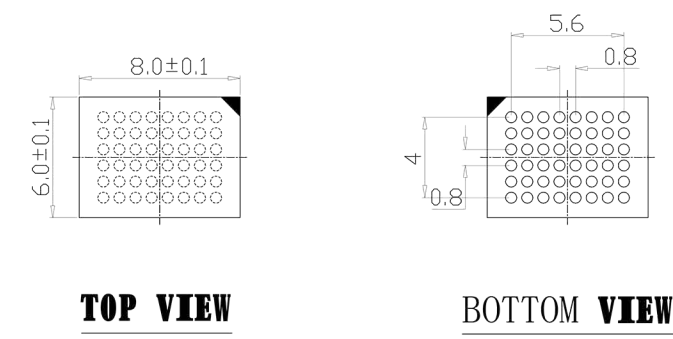

TOP VIEW

BOTTOM VIEW

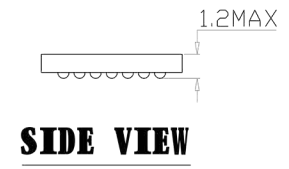

SIDE VIEW

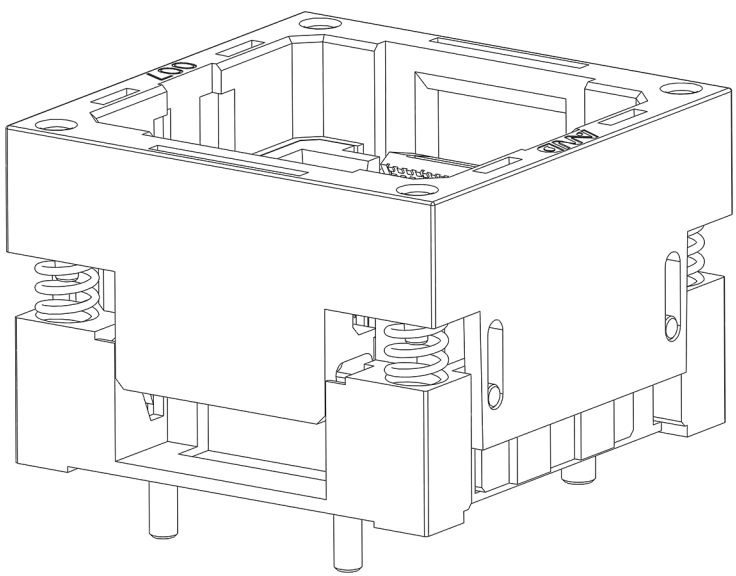

PERFORMANCE

1. Insulation Resistance: 1000MΩ Min. At DC 500V
2. Dielectric Withstanding Voltage For 1 Minute At AC 700V
3. Contact Resistance 30mΩ MAX. at 10mA and 20mV MAX.(Initial)
4. Current Rating: 1A max.
5. Operation Temperature -65°C ~+175°C
6. Contact Force 3-5g Per Pin (Normal)
7. Testing chips with balls of different size or superficial oxidation, even if no ball

No	Part Number	Name	Material	Q/ty	Note
8	310-048-D105D	IC GUIDE	PEI/PES	2	BLACK
7	310-048-C105D	SLIDER	PEI/PES	1	BLACK
6	310-048-C105D	IC HOLDER	PEI/PES	2	BLACK
5	310-048-B105D	COVER	PEI/PES	1	BLACK
4	20-B-4505B	SPRING	SUS	4	FOR COVER
3	310-048-A105D	BASE	PEI/PES	1	BLACK
2	310-048-F105D	LOCATOR	PEI/PES	3	BLACK
1	04-A-1705	CONTACT	BeCu	48	Au PLATING

PROJECTION	GENERAL TOLERANCES	±0.10	TITLE	BGA4802 SOCKET
	REV	A	CLASS	007-22048D-2102
DIMENSION:	mm	SCALE:	1:1	DRW. NO 007-BGA-0.8-48-6X8-B-0803245
APP:		DATE:		
CHECK:		DATE:		
DEGK: ENG04		DATE: 20121207		