

REVISION	DESCRIPTION	CHECK	APP	DATE	REV.NOTICE.NO
1					
2					
3					

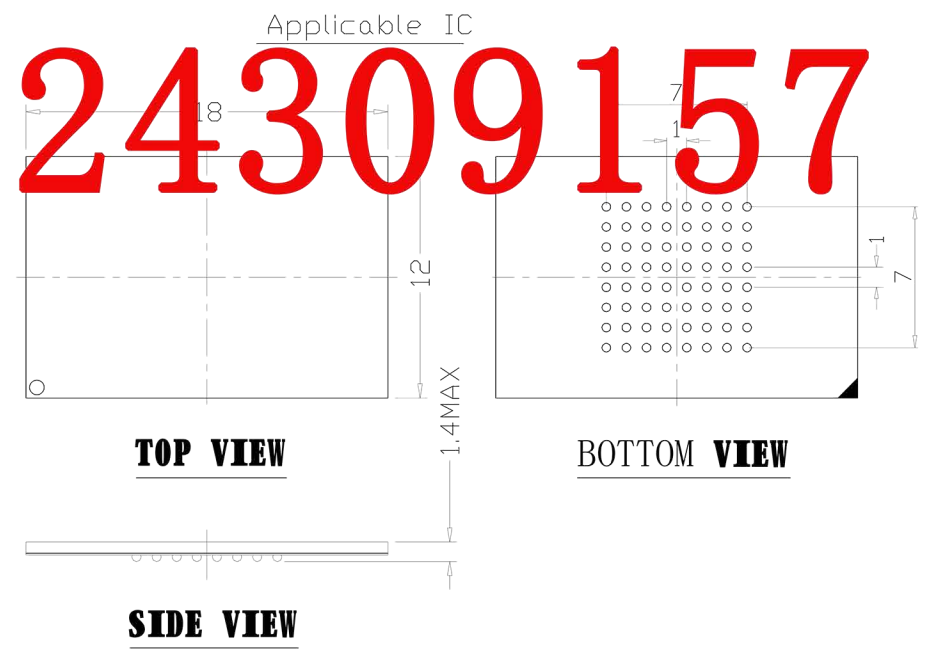
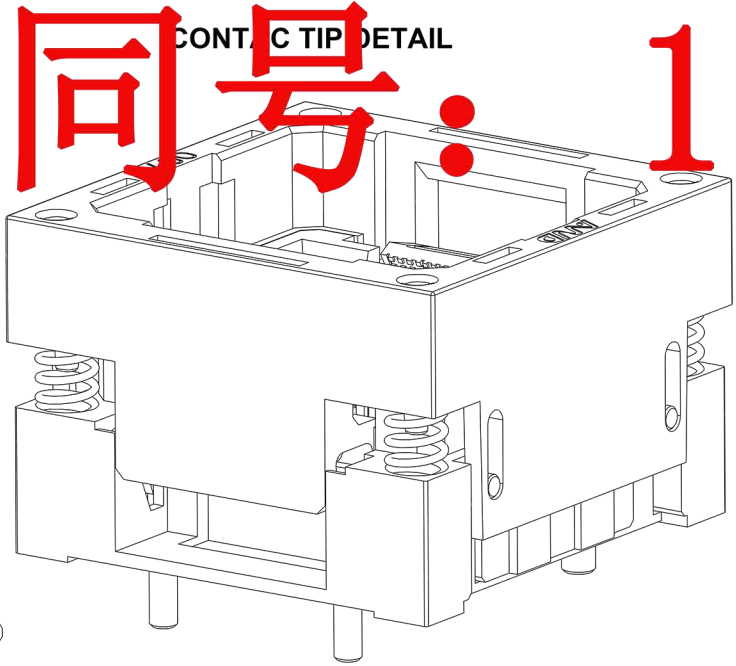
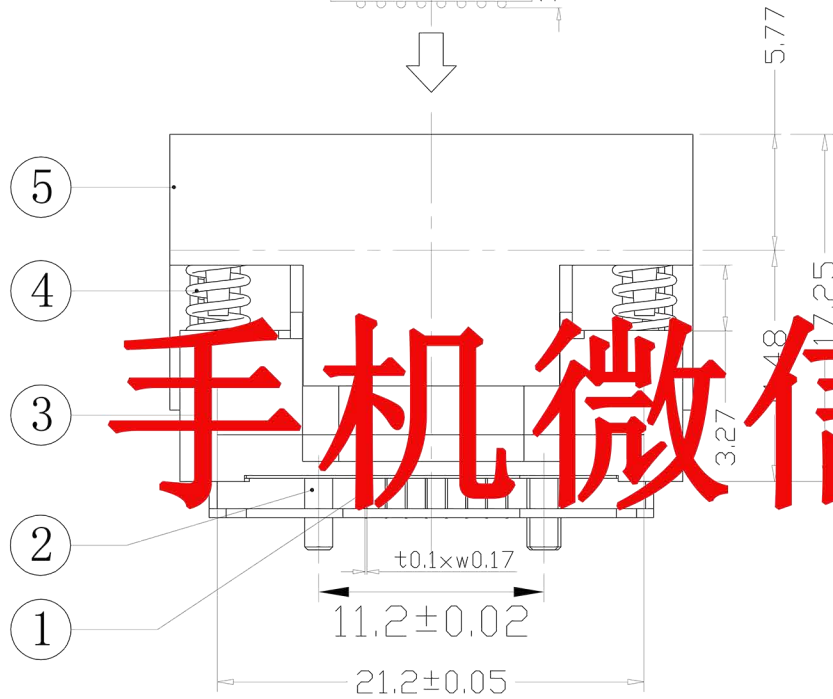
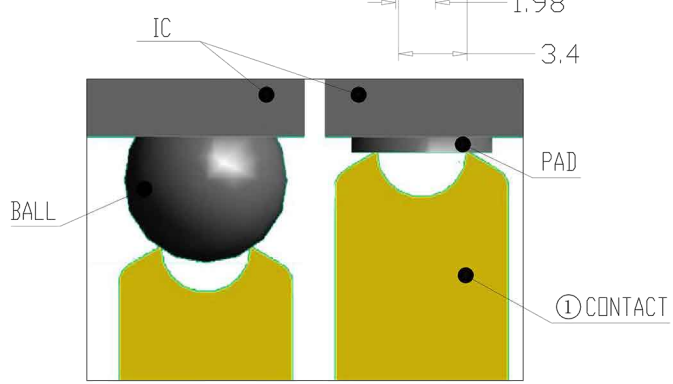
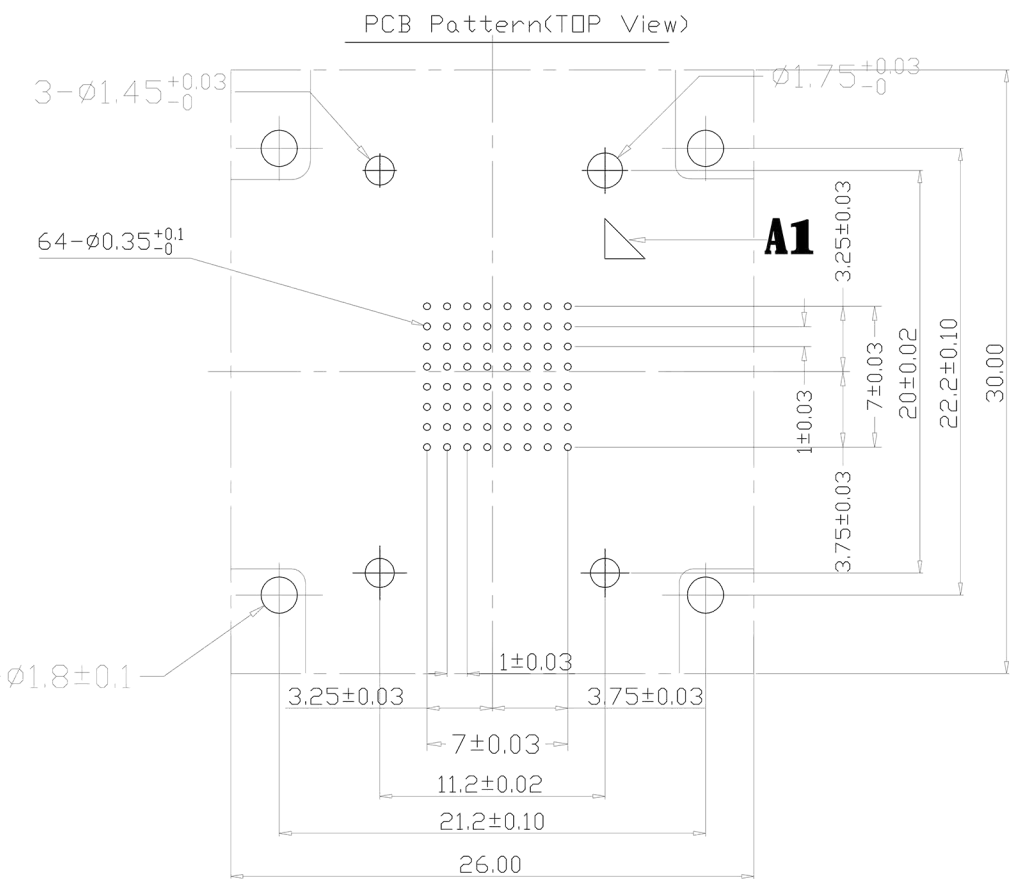
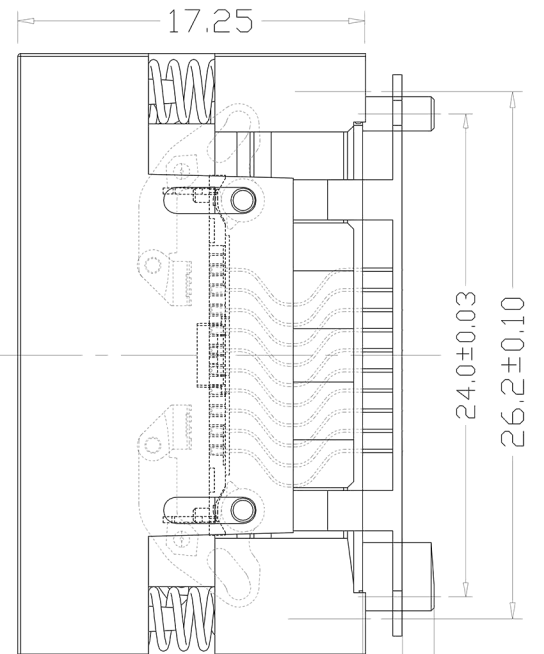
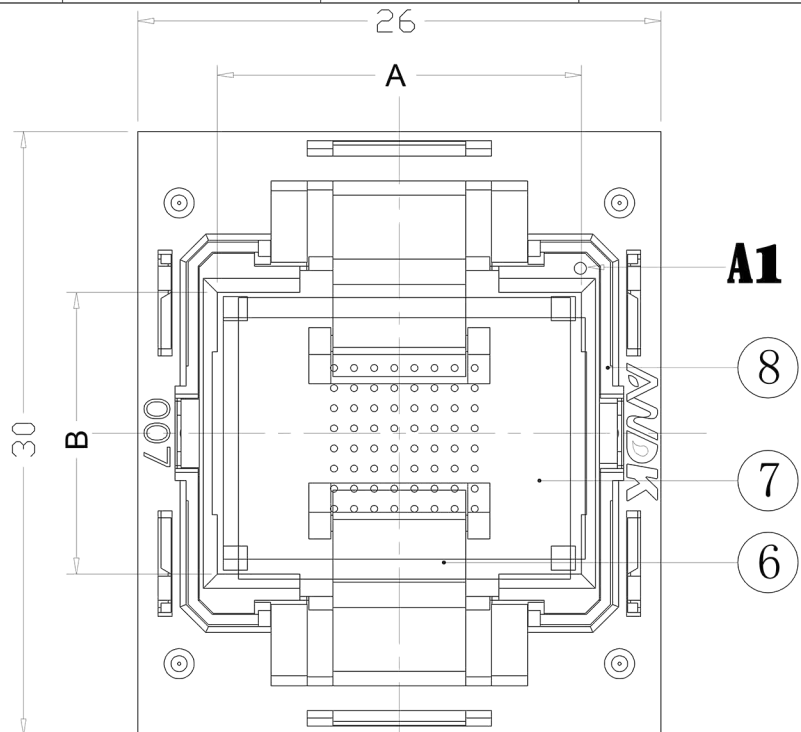

手机微信同号: 18824309157

**PERFORMANCE**

1. Insulation Resistance: 1000MΩ Min.At DC 500V
2. Dielectric Withstanding Voltage For 1 Minute At AC 700V
3. Contact Resistance 30mΩ MAX.at 10mA and 20mV MAX.(Initial)
4. Current Rating: 1A max.
5. Operation Temperature -65°C ~+175°C
6. Contact Force 3-5g Per Pin (Normal)
7. Life Span 25,000 Times (Mechanical)
8. Operation Force 1.6 Kg MAX
9. Testing chips with balls of different size or superficial oxidation,even if

No	Part Number	Name	Material	Q/ty	Note
8	310-048-D105D	IC GUIDE	PEI/PES	2	BLACK
7	310-048-C105D	SLIDER	PEI/PES	1	BLACK
6	310-048-C105D	IC HOLDER	PEI/PES	2	BLACK
5	310-048-B105D	COVER	PEI/PES	1	BLACK
4	20-B-4505B	SPRING	SUS	4	FOR COVER
3	310-048-A105D	BASE	PEI/PES	1	BLACK
2	310-048-F105D	LOCATOR	PEI/PES	3	BLACK
no ball	04-A-1705	CONTACT	BeCu	64	Au PLATING

PROJECTION	GENERAL TOLERANCES	±0.10	TITLE	BGA6402 SOCKET
	REV	A	CLASS	007-22064E-2103
DIMENSION:	mm	SCALE:	1:1	DRW. NO 007-BGA-1.0-64-12X18-B-23327
APP:		DATE:		
CHECK:		DATE:		
DEGK:	ENG02	DATE:	20120725	