

| REVISION | DESCRIPTION | CHECK | APP | DATE | REV. NOTICE .NO |
|----------|-------------|-------|-----|------|-----------------|
| 1        |             |       |     |      |                 |
| 2        |             |       |     |      |                 |
| 3        |             |       |     |      |                 |

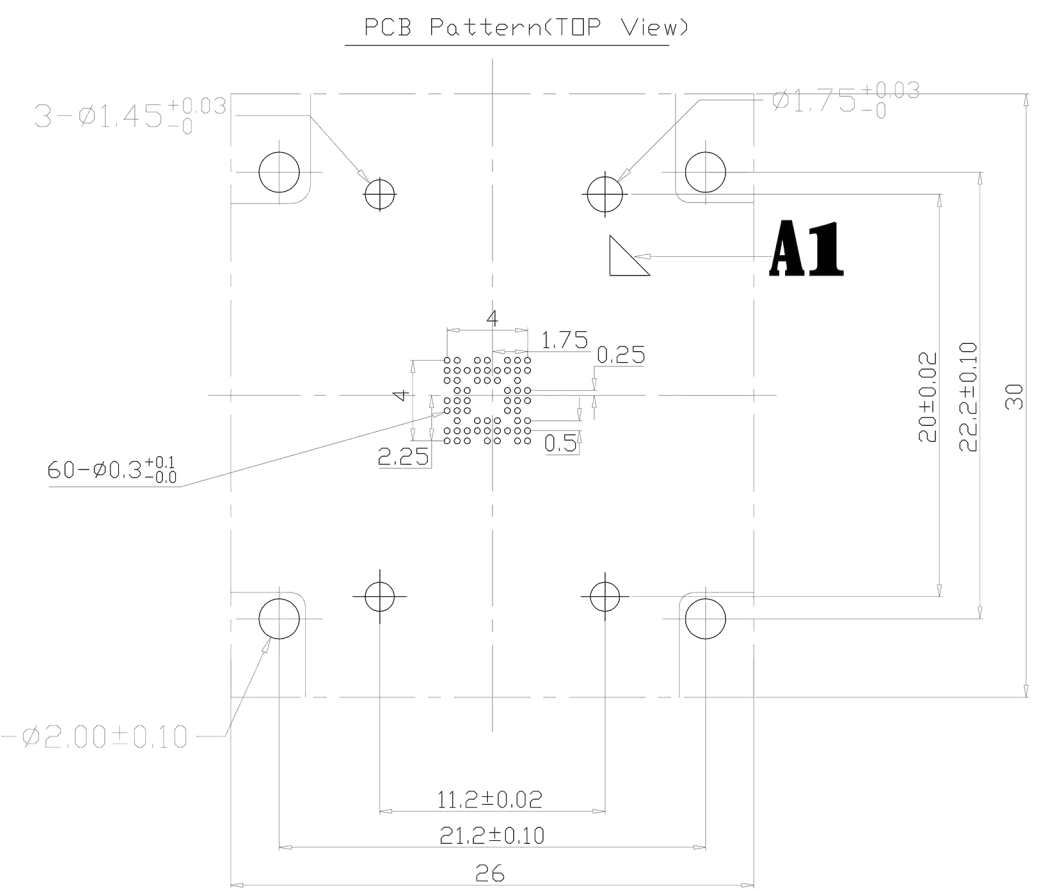

IC Loading Direction  
(Center In)

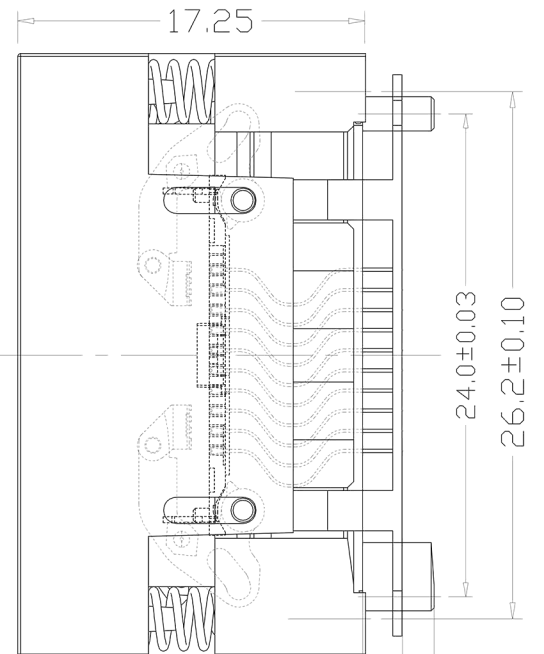
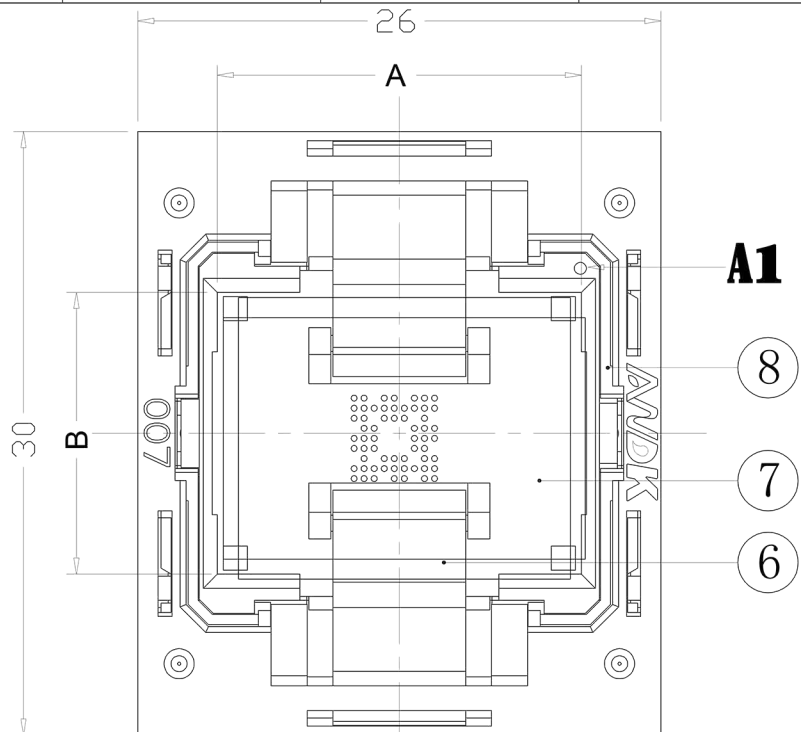
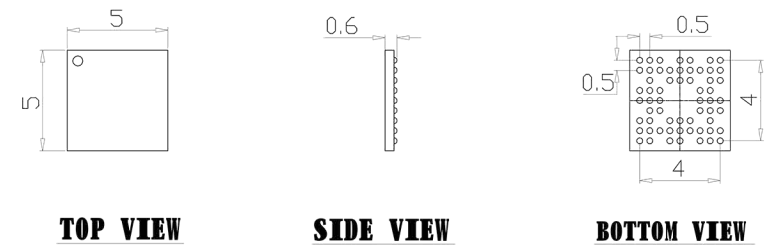
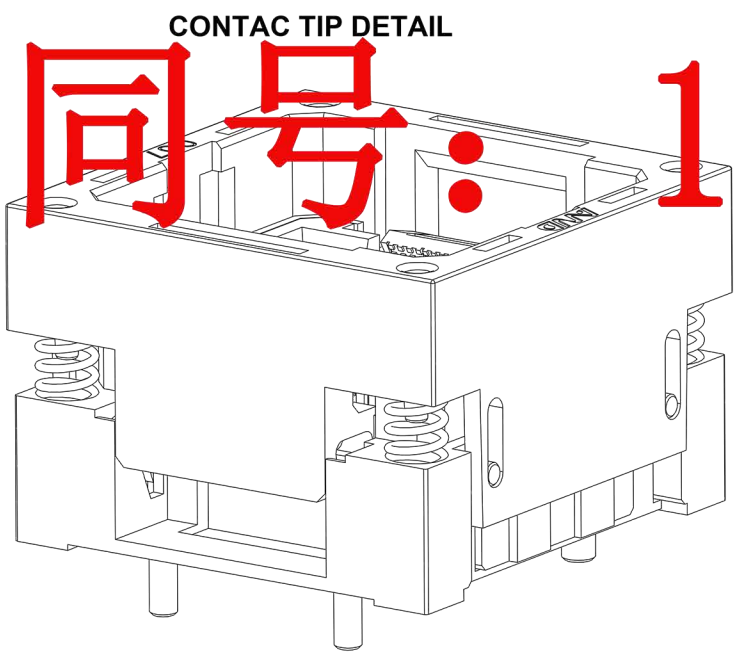
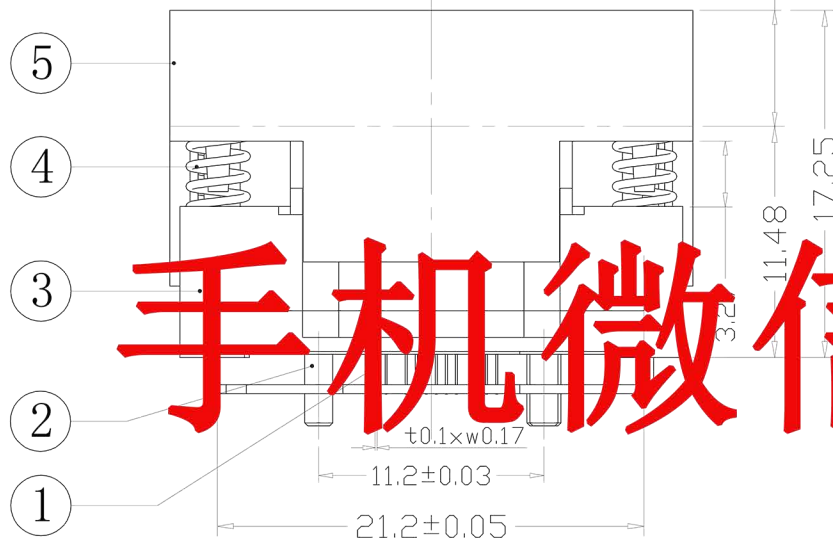
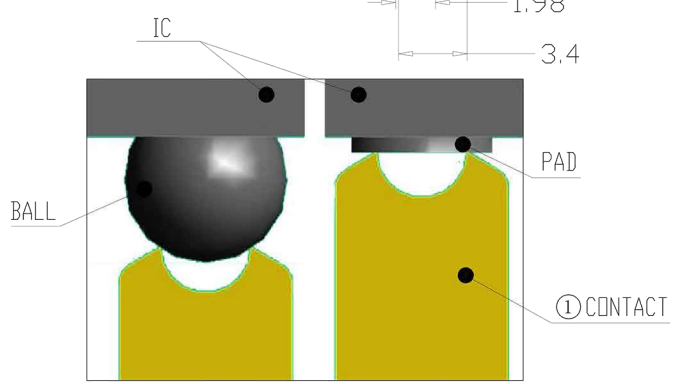

手机微信同号: 18824309157

PERFORMANCE

1. Insulation Resistance: 1000MΩ Min. At DC 500V
2. Dielectric Withstanding Voltage For 1 Minute At AC 700V
3. Contact Resistance 30mΩ MAX. at 10mA and 20mV MAX.(Initial)
4. Current Rating: 1A max.
5. Operation Temperature -65°C ~+175°C
6. Contact Force 3-5g Per Pin (Normal)
7. Testing chips with balls of different size or superficial oxidation, even if no ball

| No | Part Number   | Name      | Material | Q/ty | Note       |
|----|---------------|-----------|----------|------|------------|
| 8  | 310-048-D105D | IC GUIDE  | PEI/PES  | 2    | BLACK      |
| 7  | 310-048-C105D | SLIDER    | PEI/PES  | 1    | BLACK      |
| 6  | 310-048-C105D | IC HOLDER | PEI/PES  | 2    | BLACK      |
| 5  | 310-048-B105D | COVER     | PEI/PES  | 1    | BLACK      |
| 4  | 20-B-4505B    | SPRING    | SUS      | 4    | FOR COVER  |
| 3  | 310-048-A105D | BASE      | PEI/PES  | 1    | BLACK      |
| 2  | 310-048-F105D | LOCATOR   | PEI/PES  | 3    | BLACK      |
| 1  | 04-A-1705     | CONTACT   | BeCu     | 60   | Au PLATING |

| PROJECTION  | GENERAL TOLERANCES | ±0.10          | TITLE | BGA60 SOCKET                    |
|-------------|--------------------|----------------|-------|---------------------------------|
|             | REV                | A              | CLASS | 007-22060E-2101                 |
| DIMENSION:  | mm                 | SCALE:         | 1:1   | DRW. NO 007-BGA-0.5-60-5X5-B-01 |
| APP:        |                    | DATE:          |       |                                 |
| CHECK:      |                    | DATE:          |       |                                 |
| DEGK: ENG04 |                    | DATE: 20121129 |       |                                 |