

REVISION	DESCRIPTION	CHECK	APP	DATE	REV.NOTICE.NO
△1					
△2					
△3					

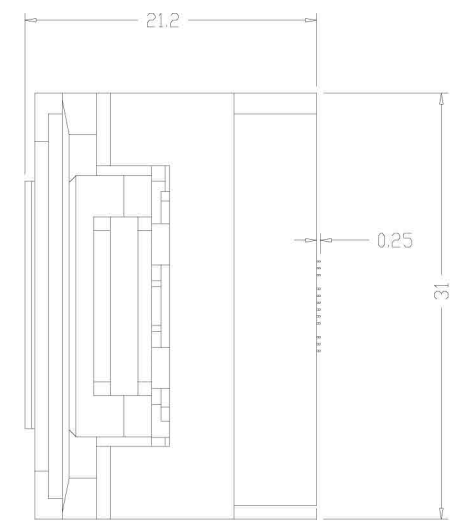

PCB PATTERN (TOP VIEW)

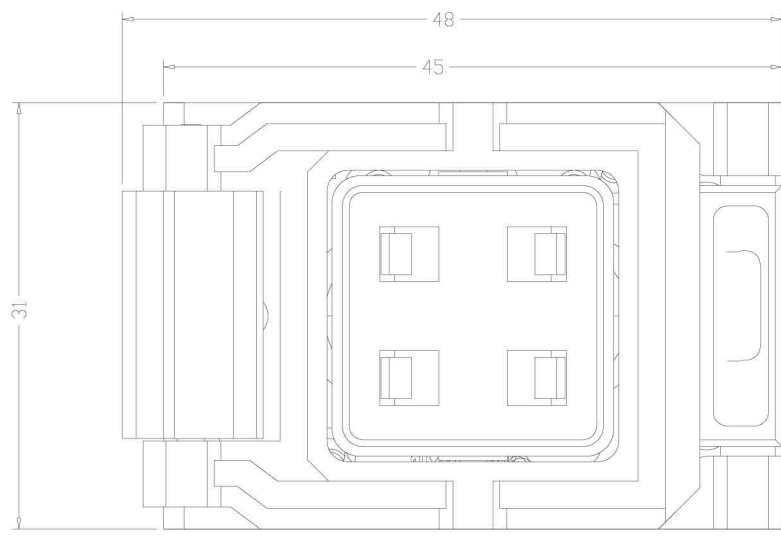
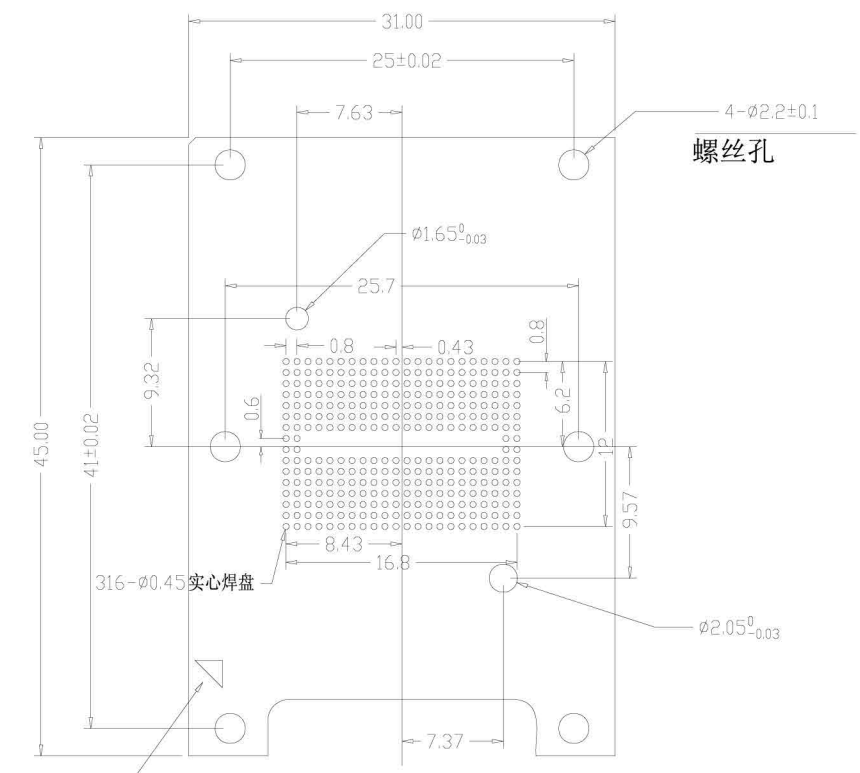

PERFORMANCE

- 1、Insulation Resistance: 1000MΩ Min.At DC 500V
- 2、Dielectric Withstanding Voltage For 1 Minute At AC 700V
- 3、CoNSact Resistance 30mΩ MAX. at 10mA and 20mV MAX.(Initial)
- 4、Current Rating: 1A max.
- 5、Operation Temperature -55°C ~+85°C
- 6、Life Span 15,000 Times (Mechanical)

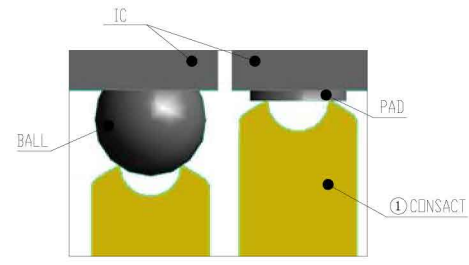

CONSAC TIP DETAIL

手机微信同号: 18824309157

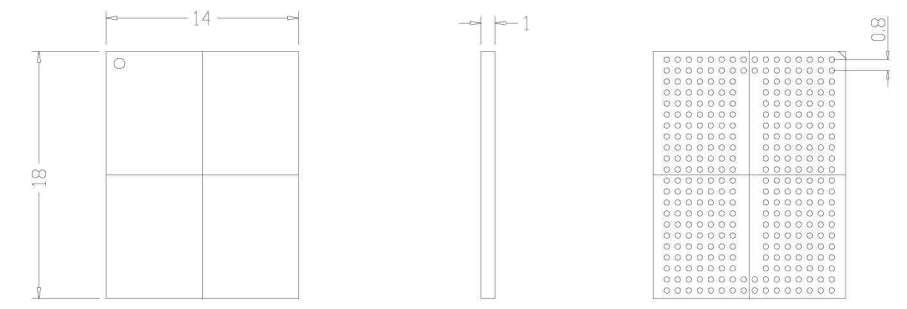
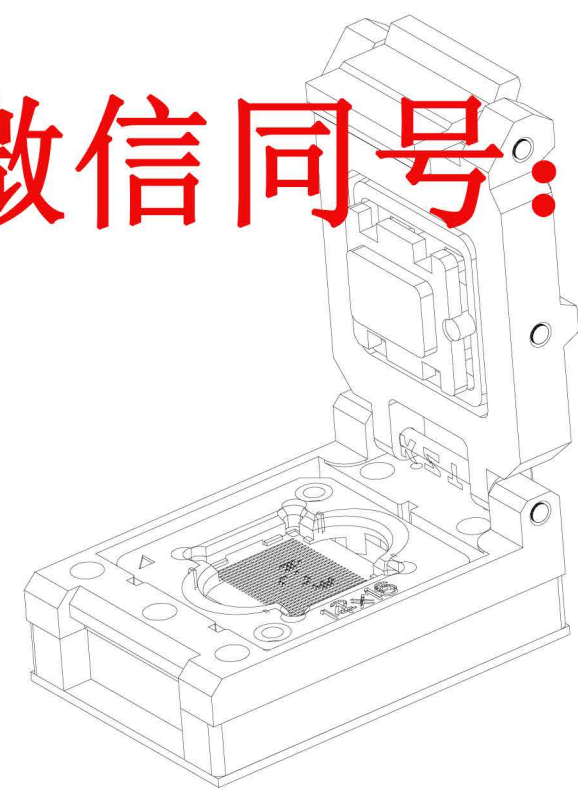
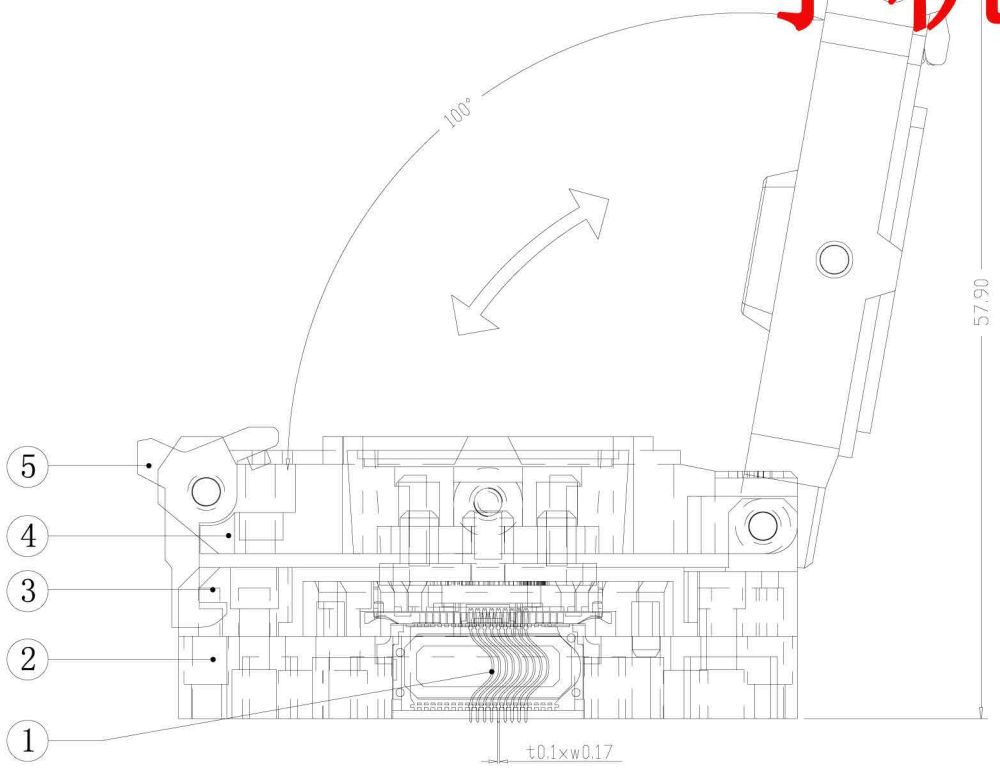

TOP VIEW SIDE VIEW BOTTOM VIEW

No	Part Number	Name	Material	Q/ty	Note
5	P0001-04	LATCH	PEI	1	BLACK
4	P0001-02	OUTER LID	PEI	1	BLACK
3	P0001-01	BASE	PEI	1	BLACK
2	P0001-00	TOP PLATE	PEI	1	BLACK
1	04-A-1705	CONTACT	BeCu	316	Au PLATING

TOLERANCE	PROJECTION	GENERAL TOLERANCES	±0.10	TITLE	BGA316-0.8 SOCKET
X. ± 0.50	DIMENSION: mm	REV	A	CLASS	BGA316-0.8-CP01NS
X. X ± 0.25	APP:	SCALE: 1:1	DATE:	DRW. NO	P2002-5316D-1201 (14X18)
X. XX ± 0.10	CHECK:	DATE:			
X. XXX ± 0.05	DEGK: ENG03	DATE: 20170315			